

NTZD3154N

Small Signal MOSFET

20 V, 540 mA, Dual N-Channel

Features

- Low $R_{DS(on)}$ Improving System Efficiency
- Low Threshold Voltage
- Small Footprint 1.6 x 1.6 mm
- ESD Protected Gate
- These are Pb-Free Devices

Applications

- Load/Power Switches
- Power Supply Converter Circuits
- Battery Management
- Cell Phones, Digital Cameras, PDAs, Pagers, etc.

MAXIMUM RATINGS ($T_J = 25^\circ\text{C}$ unless otherwise noted.)

Parameter		Symbol	Value	Unit	
Drain-to-Source Voltage		V_{DSS}	20	V	
Gate-to-Source Voltage		V_{GS}	± 6.0	V	
Continuous Drain Current (Note 1)	Steady State	I_D	$T_A = 25^\circ\text{C}$	540	mA
			$T_A = 85^\circ\text{C}$	390	
Power Dissipation (Note 1)	Steady State	P_D	250	mW	
Continuous Drain Current (Note 1)	$t \leq 5 \text{ s}$	I_D	$T_A = 25^\circ\text{C}$	570	mA
			$T_A = 85^\circ\text{C}$	410	
Power Dissipation (Note 1)	$t \leq 5 \text{ s}$	P_D	280	mW	
Pulsed Drain Current	$t_p = 10 \mu\text{s}$	I_{DM}	1.5	A	
Operating Junction and Storage Temperature		T_J, T_{STG}	-55 to 150	$^\circ\text{C}$	
Source Current (Body Diode)		I_S	350	mA	
Lead Temperature for Soldering Purposes (1/8" from case for 10 s)		T_L	260	$^\circ\text{C}$	

THERMAL RESISTANCE RATINGS

Parameter	Symbol	Max	Unit
Junction-to-Ambient – Steady State (Note 1)	$R_{\theta JA}$	500	$^\circ\text{C/W}$
Junction-to-Ambient – $t \leq 5 \text{ s}$ (Note 1)		447	

Stresses exceeding Maximum Ratings may damage the device. Maximum Ratings are stress ratings only. Functional operation above the Recommended Operating Conditions is not implied. Extended exposure to stresses above the Recommended Operating Conditions may affect device reliability.

1. Surface mounted on FR4 board using 1 in sq pad size (Cu. area = 1.127 in sq [1 oz] including traces).



ON Semiconductor®

<http://onsemi.com>

$V_{(BR)DSS}$	$R_{DS(on)}$ Typ	I_D Max (Note 1)
20	400 m Ω @ 4.5 V	540 mA
	500 m Ω @ 2.5 V	
	700 m Ω @ 1.8 V	

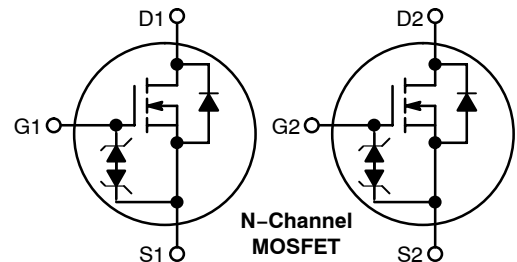

MARKING DIAGRAM

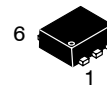

SOT-563-6
CASE 463A

- TV = Specific Device Code
- M = Date Code
- = Pb-Free Package

(Note: Microdot may be in either location)

PINOUT: SOT-563

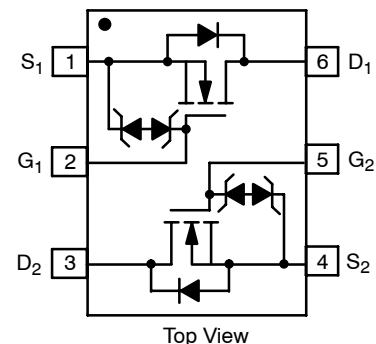

ORDERING INFORMATION

See detailed ordering and shipping information in the package dimensions section on page 4 of this data sheet.

NTZD3154N

ELECTRICAL CHARACTERISTICS ($T_J = 25^\circ\text{C}$ unless otherwise noted.)

Parameter	Symbol	Test Condition	Min	Typ	Max	Unit	
OFF CHARACTERISTICS							
Drain-to-Source Breakdown Voltage	$V_{(BR)DSS}$	$V_{GS} = 0\text{ V}, I_D = 250\ \mu\text{A}$	20	-	-	V	
Drain-to-Source Breakdown Voltage Temperature Coefficient	$V_{(BR)DSS}/T_J$	-	-	14	-	mV/°C	
Zero Gate Voltage Drain Current	I_{DSS}	$V_{GS} = 0\text{ V}$ $V_{DS} = 16\text{ V}$	$T_J = 25^\circ\text{C}$	-	-	1.0	μA
			$T_J = 125^\circ\text{C}$	-	-	5.0	
Gate-to-Source Leakage Current	I_{GSS}	$V_{DS} = 0\text{ V}, V_{GS} = \pm 4.5\text{ V}$	-	-	± 5.0	μA	

ON CHARACTERISTICS (Note 3)

Gate Threshold Voltage	$V_{GS(TH)}$	$V_{GS} = V_{DS}, I_D = 250\ \mu\text{A}$	0.45	-	1.0	V
Negative Threshold Temperature Coefficient	$V_{GS(TH)}/T_J$	-	-	2.0	-	mV/°C
Drain-to-Source On Resistance	$R_{DS(on)}$	$V_{GS} = 4.5\text{ V}, I_D = 540\text{ mA}$	-	0.4	0.55	Ω
		$V_{GS} = 2.5\text{ V}, I_D = 500\text{ mA}$	-	0.5	0.7	
		$V_{GS} = 1.8\text{ V}, I_D = 350\text{ mA}$	-	0.7	0.9	
Forward Transconductance	g_{FS}	$V_{DS} = 10\text{ V}, I_D = 540\text{ mA}$	-	1.0	-	S

CHARGES AND CAPACITANCES

Input Capacitance	C_{ISS}	$V_{GS} = 0\text{ V}, f = 1.0\text{ MHz}, V_{DS} = 16\text{ V}$	-	80	150	μF
Output Capacitance	C_{OSS}		-	13	25	
Reverse Transfer Capacitance	C_{RSS}		-	10	20	
Total Gate Charge	$Q_{G(TOT)}$	$V_{GS} = 4.5\text{ V}, V_{DS} = 10\text{ V}; I_D = 540\text{ mA}$	-	1.5	2.5	nC
Threshold Gate Charge	$Q_{G(TH)}$		-	0.1	-	
Gate-to-Source Charge	Q_{GS}		-	0.2	-	
Gate-to-Drain Charge	Q_{GD}		-	0.35	-	

SWITCHING CHARACTERISTICS, $V_{GS} = V$ (Note 4)

Turn-On Delay Time	$t_{d(ON)}$	$V_{GS} = 4.5\text{ V}, V_{DD} = 10\text{ V}, I_D = 540\text{ mA},$ $R_G = 10\ \Omega$	-	6.0	-	ns
Rise Time	t_r		-	4.0	-	
Turn-Off Delay Time	$t_{d(OFF)}$		-	16	-	
Fall Time	t_f		-	8.0	-	

DRAIN-SOURCE DIODE CHARACTERISTICS

Forward Diode Voltage	V_{SD}	$V_{GS} = 0\text{ V},$ $I_S = 350\text{ mA}$	$T_J = 25^\circ\text{C}$	-	0.7	1.2	V
			$T_J = 125^\circ\text{C}$	-	0.6	-	
Reverse Recovery Time	t_{RR}	$V_{GS} = 0\text{ V}, dI_{SD}/dt = 100\text{ A}/\mu\text{s}, I_S = 350\text{ mA}$	-	6.5	-	ns	

2. Surface-mounted on FR4 board using 1 in. sq. pad size (Cu. area = 1.127 in sq [1 oz] including traces).
3. Pulse Test: pulse width $\leq 300\ \mu\text{s}$, duty cycle $\leq 2\%$.
4. Switching characteristics are independent of operating junction temperatures.

NTZD3154N

TYPICAL PERFORMANCE CURVES ($T_J = 25^\circ\text{C}$ unless otherwise noted)

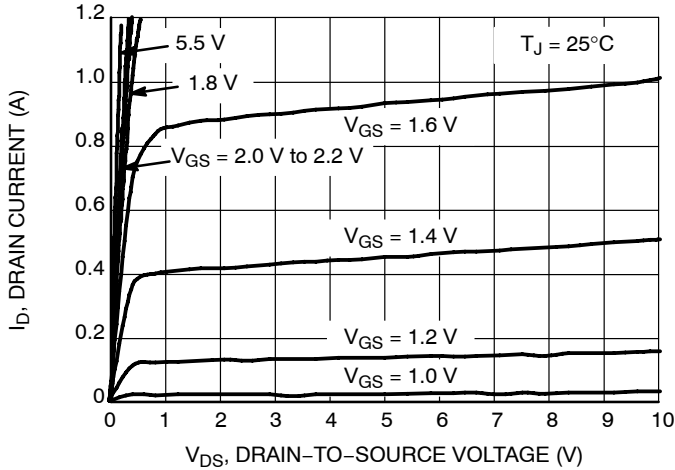

Figure 1. On-Region Characteristics

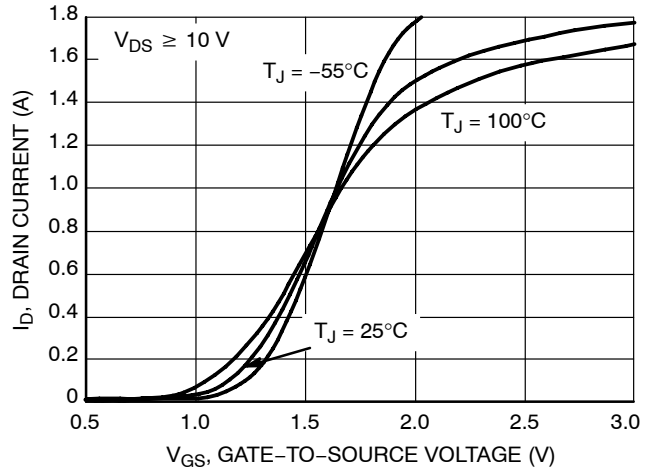

Figure 2. Transfer Characteristics

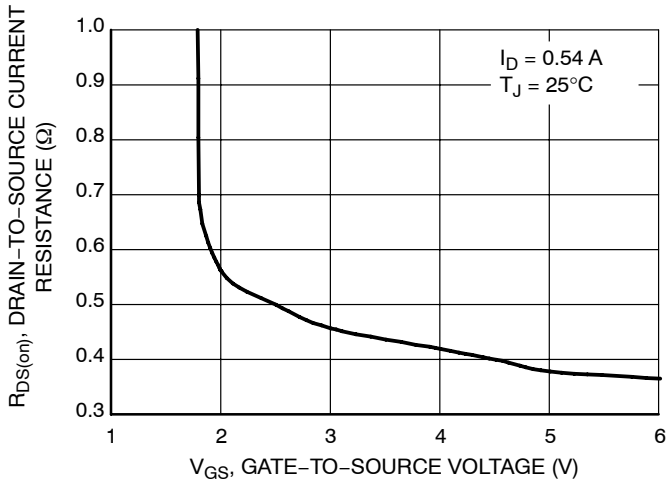

Figure 3. On-Resistance versus Gate-to-Source Voltage

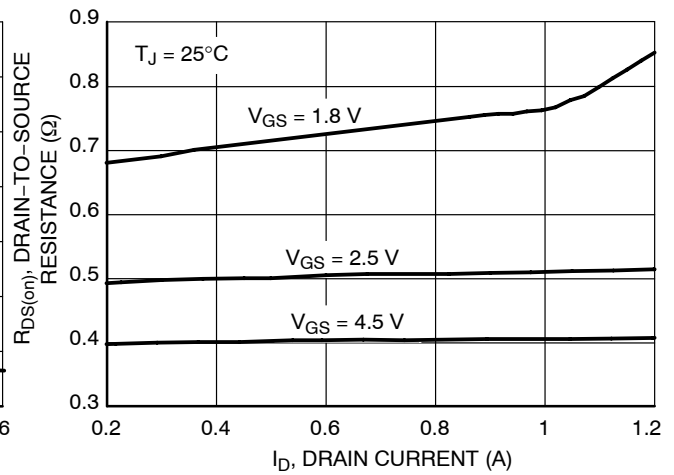

Figure 4. On-Resistance versus Drain Current and Gate Voltage

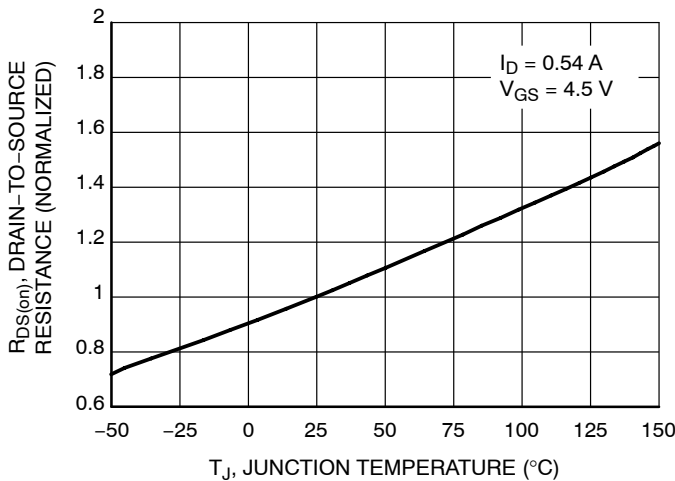

Figure 5. On-Resistance Variation with Temperature

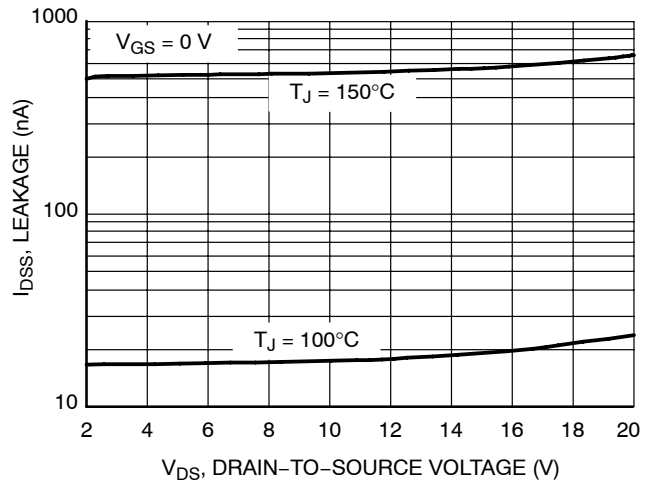

Figure 6. Drain-to-Source Leakage Current versus Voltage

NTZD3154N

TYPICAL PERFORMANCE CURVES ($T_J = 25^\circ\text{C}$ unless otherwise noted)

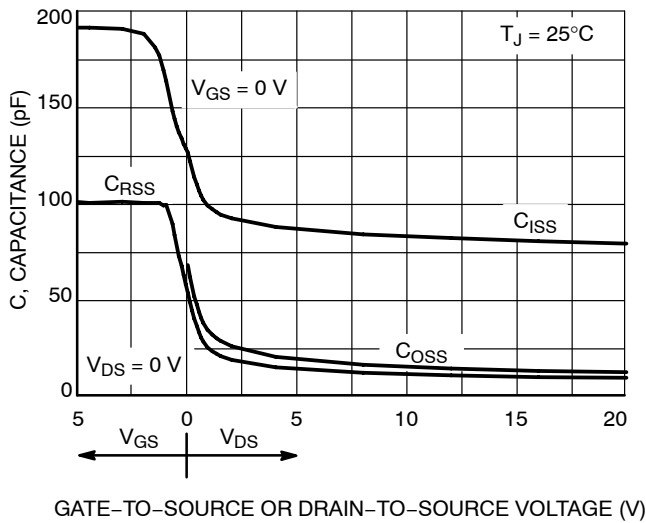

Figure 7. Capacitance Variation

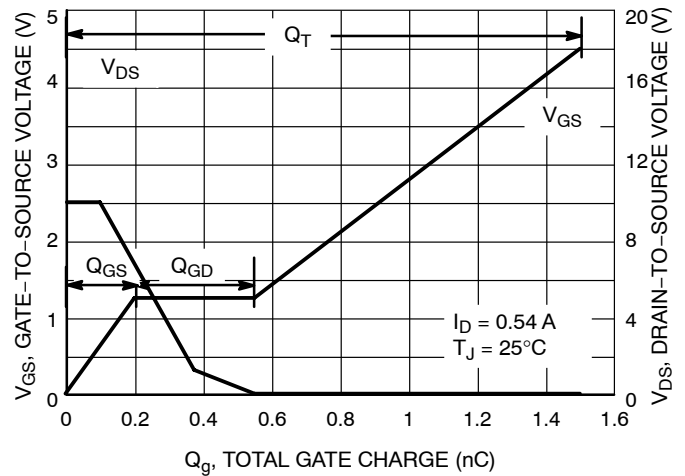

Figure 8. Gate-to-Source and Drain-to-Source Voltage versus Total Charge

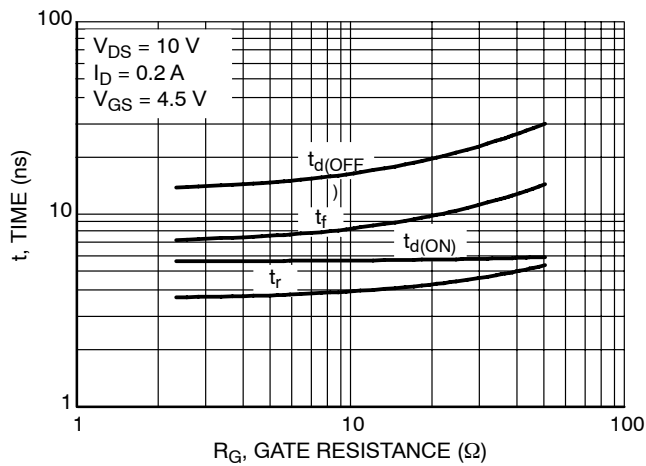

Figure 9. Resistive Switching Time Variation versus Gate Resistance

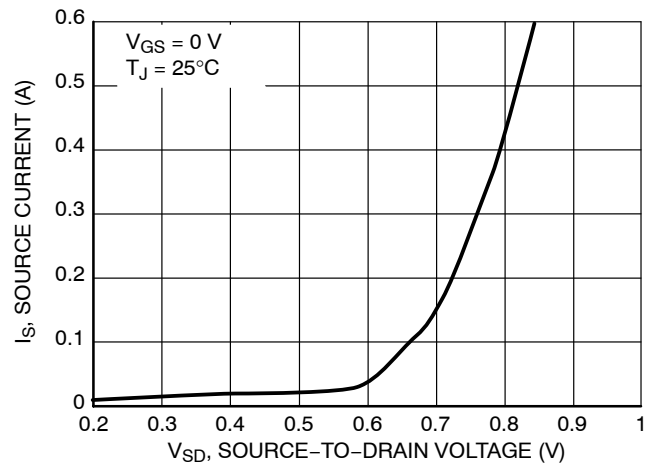

Figure 10. Diode Forward Voltage versus Current

ORDERING INFORMATION

Device	Package	Shipping
NTZD3154NT1G	SOT-563 (Pb-Free)	4000 / Tape & Reel
NTZD3154NT5G	SOT-563 (Pb-Free)	8000 / Tape & Reel

†For information on tape and reel specifications, including part orientation and tape sizes, please refer to our Tape and Reel Packaging Specifications Brochure, BRD8011/D.

NTZD3154N

PACKAGE DIMENSIONS

SOT-563, 6 LEAD
CASE 463A-01
ISSUE F

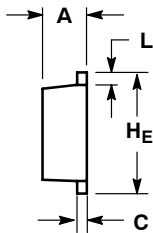
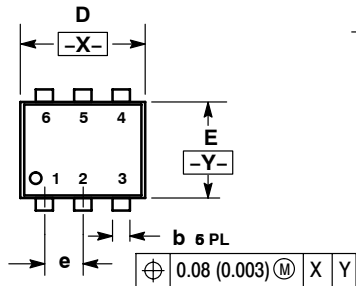

NOTES:

1. DIMENSIONING AND TOLERANCING PER ANSI Y14.5M, 1982.
2. CONTROLLING DIMENSION: MILLIMETERS
3. MAXIMUM LEAD THICKNESS INCLUDES LEAD FINISH THICKNESS. MINIMUM LEAD THICKNESS IS THE MINIMUM THICKNESS OF BASE MATERIAL.

DIM	MILLIMETERS			INCHES		
	MIN	NOM	MAX	MIN	NOM	MAX
A	0.50	0.55	0.60	0.020	0.021	0.023
b	0.17	0.22	0.27	0.007	0.009	0.011
C	0.08	0.12	0.18	0.003	0.005	0.007
D	1.50	1.60	1.70	0.059	0.062	0.066
E	1.10	1.20	1.30	0.043	0.047	0.051
e	0.5 BSC			0.02 BSC		
L	0.10	0.20	0.30	0.004	0.008	0.012
HE	1.50	1.60	1.70	0.059	0.062	0.066

SOLDERING FOOTPRINT*

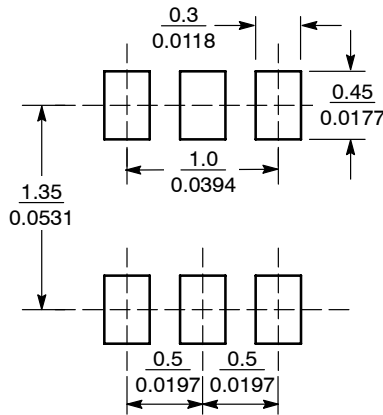

SCALE 20:1 (mm/inches)

*For additional information on our Pb-Free strategy and soldering details, please download the ON Semiconductor Soldering and Mounting Techniques Reference Manual, SOLDERRM/D.

ON Semiconductor and are registered trademarks of Semiconductor Components Industries, LLC (SCILLC). SCILLC reserves the right to make changes without further notice to any products herein. SCILLC makes no warranty, representation or guarantee regarding the suitability of its products for any particular purpose, nor does SCILLC assume any liability arising out of the application or use of any product or circuit, and specifically disclaims any and all liability, including without limitation special, consequential or incidental damages. "Typical" parameters which may be provided in SCILLC data sheets and/or specifications can and do vary in different applications and actual performance may vary over time. All operating parameters, including "Typicals" must be validated for each customer application by customer's technical experts. SCILLC does not convey any license under its patent rights nor the rights of others. SCILLC products are not designed, intended, or authorized for use as components in systems intended for surgical implant into the body, or other applications intended to support or sustain life, or for any other application in which the failure of the SCILLC product could create a situation where personal injury or death may occur. Should Buyer purchase or use SCILLC products for any such unintended or unauthorized application, Buyer shall indemnify and hold SCILLC and its officers, employees, subsidiaries, affiliates, and distributors harmless against all claims, costs, damages, and expenses, and reasonable attorney fees arising out of, directly or indirectly, any claim of personal injury or death associated with such unintended or unauthorized use, even if such claim alleges that SCILLC was negligent regarding the design or manufacture of the part. SCILLC is an Equal Opportunity/Affirmative Action Employer. This literature is subject to all applicable copyright laws and is not for resale in any manner.

PUBLICATION ORDERING INFORMATION

LITERATURE FULFILLMENT:
Literature Distribution Center for ON Semiconductor
P.O. Box 61312, Phoenix, Arizona 85082-1312 USA
Phone: 480-829-7710 or 800-344-3860 Toll Free USA/Canada
Fax: 480-829-7709 or 800-344-3867 Toll Free USA/Canada
Email: orderlit@onsemi.com

N. American Technical Support: 800-282-9855 Toll Free USA/Canada

Japan: ON Semiconductor, Japan Customer Focus Center
2-9-1 Kamimeguro, Meguro-ku, Tokyo, Japan 153-0051
Phone: 81-3-5773-3850

ON Semiconductor Website: <http://onsemi.com>

Order Literature: <http://www.onsemi.com/litorder>

For additional information, please contact your local Sales Representative.